

**WATERLESS**.com  
the innovative brand since 1991

**30 YEARS**  
LEADING THE WAY TO  
WATER EFFICIENCY  
**WATERLESS**  
SINCE 1991

# BAJA # 2104

VITREOUS CHINA MODEL



## SPECIFICATION, INSTALLATION, AND MAINTENANCE MANUAL

### URINAL BOX CONTENTS:

1-Urinal; 2-EcoTrap® Inserts; 1-Wall Hangers;  
2-Plastic Anchors; 2-Screws; 1-Rubber Gasket

**FOR INSTALLATION,**  
*as needed, purchase separately:*



#### iPack #6009

1 x #1114 BlueSeal  
1 x #4001 X-Traptor Tool  
1 x #4002 PortionAid

#### Brass Flange #5001



**ADDITIONAL PRODUCTS,**  
*purchase separately:*



#### NviroClean™ #1614

The Simple Cleaner...  
Just Spray and Walk Away!  
Quart Size Bottle

#### EverPrime® #1514

For dried out, smelly floor  
drains, hvac traps and more  
The simple \$2.30 solution.



## IMPORTANT!

**DO NOT INSTALL NO-FLUSH™ URINALS: 1. ON CLOGGED OR UNCLEANED SEWER LINES or 2. TO UNVENTED DRAIN LINES**  
TO MAINTAIN WARRANTY, SEWER LINES NEED TO BE PROFESSIONALLY CLEANED (SNAKED) AND WORK DOCUMENTED PRIOR  
TO INSTALLATION. NO WARRANTIES, EITHER ASSUMED OR IMPLIED, ARE GIVEN FOR PROPER FUNCTIONING OF NO-FLUSH™  
URINALS WITHOUT DOCUMENTATION. **CHECK ROUGH-IN HEIGHT BEFORE INSTALLATION FOR CORRECT URINAL HEIGHT.**

**WATERLESS CO. INC. • Vista CA 92081 USA**

**Toll Free: (800) 244-6364 • Tel: (760) 727-7723 • www.waterless.com**

*In keeping with our policy of product improvement, Waterless Co. reserves the right to change product specifications at any time without notice. It is the responsibility of the specifier, installer and wholesale seller to confirm specification at time of sale or installation. No responsibility is assumed, claimed or accepted by Waterless Co. Inc. Please observe 10 day merchandise return policy.*

© Waterless Co. Inc. 2021  
REVISED 120720

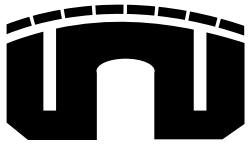

**WATERLESS**.com  
the innovative brand since 1991



## INSTALLATION INSTRUCTIONS

### BAJA #2104

VITREOUS CHINA

#### NOTE:

No flushometer needed for fixture, provide suitable reinforcements for all wall supports and carriers. ADA: Requires urinal rim to be mounted 17" above finished floor. Dimensions for fixtures are nominal and may vary within the range of tolerances established by ANSI Standard A112.19.19 and ANSI Z124.9. Measurements are subject to change or cancellation. No responsibility is assumed. UPC®; others. For copper DWV drain lines ascertain and document that the installed lines are not corroded or show "channeling".

**Please leave this Installation/Care sheet with the owner/user as it contains important information.**

#### BOX CONTENTS<sup>2</sup>:

2-EcoTrap® Inserts; 1- Wall Hanger; 2-Plastic Anchors; 2-Screws;  
1-Rubber Gasket

#### FOR NEW CONSTRUCTION ONLY

**(Needs to be ordered separately):**

#5001 Brass Flange and Hardware.

#### TOOLS NEEDED:

Screwdriver; 5/16" (7.9mm) Masonry Drill Bit and Drill; Putty Knife; Water Supply Cap (for retrofit only); Wrench; Caulk

#### BEFORE YOU BEGIN:

- **Do not** install *No-Flush™* urinals without prior waste line clean out. **Do not double trap** (remove any other trap in drain line).
- Please assure that the new urinal has the correct rough-in dimensions.
- When working with highly polished plastic or ceramic products, please use care in handling the unit during installation to avoid scratches or chip marks.
- Over-tightening bolts and screws may result in damage to the urinal.
- Measure drain line height for correct urinal height.

#### TO REMOVE EXISTING URINAL:

Turn off the water supply. Flush the urinal to drain valve and scoop or sponge out remaining water in urinal. Disconnect the flushometer valve completely and cap water supply line at tile. Remove urinal shell from wall and clean off any residues from wall and flange.

#### BEFORE YOU INSTALL URINAL:

**Do not** install *No-Flush™* urinal without prior waste line clean out. Existing scaling and debris in the waste line will inhibit the flow of waste from Waterless™ urinal and its proper functioning can not be guaranteed. *No-Flush™* urinals are engineered, however, to reduce waste line scaling.

#### TO INSTALL NO-FLUSH™ URINAL:

- Assumes the existing flange from a prior flushed urinal is used or for new construction, a new flange is installed to the drain line.
- Assure that flange holes are lined up horizontally. Insert 5/16" All-Thread studs into existing flange holds.
- Set supplied rubber gasket on installed flange. **Do not use wax gasket.** If using wax gasket, assure that no wax materials protrude into interior drain line openings.
- Install wall hanger(s) with provided anchors and screws.
- Carefully align/set urinal onto wall hanger(s) and lower urinal onto flange studs through *AllFlange™* recess in urinal. If alignment is needed, remove urinal, reset hanger(s) and hang urinal again as described above.
- Use washers and nuts and hand tighten on studs to hold urinal in place. Then tighten nuts evenly. **Avoid over-tightening.**
- **Caution:** Do not rock or lift urinal after placement. Seal gasket may slip and not be water tight. Do not double ring for leak repair.
- Using a bucket of water, at least 5 gallons, pour water down urinal drain hole to test seal tightness. Check for leaks on bottom of urinal and wall.
- Caulk urinal, leaving approximately 8" (203mm) on bottom of urinal uncaulked (in case of leakage).

#### INITIAL START-UP:

Wipe urinal clean with soft moist cloth. Take enclosed plastic EcoTrap® insert. Fill it with water under faucet in sink. Set EcoTrap® insert into trapway. **Push down below rim of trapway.** Add 3 Oz. of BlueSeal® trap liquid. **Done!** (Note: Plumber's grease can be used around edges of EcoTrap® insert to ease insertion into trapway.)

#### CLEANING AND CARE:

**Do not use any harsh abrasive cleaners as those can harm the surface effectiveness and thereby void the product's warranty. NviroClean™ (#1614) is a very effective and efficient cleaner. Simply spray and walk away!**

# BAJA™

## MODEL # 2104 WATERLESS NO-FLUSH URINAL



**EcoTrap®  
Inside!**



### APPLICATION

- Commercial and Residential Use

### FURNISHED WITH

- One unit integrated wall hanger
- AllFlange™ slots for flange bolts
- Fastening hardware
- Gasket
- **Two EcoTraps®**, vertical trap design

### NOTE:

- Adequate BlueSeal® trap liquid to be provided for EcoTrap® of urinal, not furnished.
- Item #5001 Brass Flange to be purchased separately, if needed, for new construction.

### COLORS

Standard white; other colors available

### WARRANTY

3 Year Limited Warranty.



**WATERLESS CO. INC. 800.244.6364**

*In keeping with our policy of product improvement, Waterless Co. reserves the right to change product specifications at any time without notice. It is the responsibility of the specifier, installer and wholesale seller to confirm specification at time of sale or installation. No responsibility is assumed, claimed or accepted by Waterless Co. Inc.*

### DESCRIPTION

Waterless Co. Inc. No-Flush™ urinal Model #2104 Baja™, wall hung, made of Vitreous China material (VC) **for commercial and residential use.** Urinal to have elongated rim, a full 2" ceramic interior drain and 2" flanged waste outlet; suitable for direct connection to a 2" waste at the wall. Supplied EcoTrap® insert required. Trap insert to be of a vertical flow type with 360 degree perimeter openings and installed by press fit. Trap must be replaceable and refillable. Trap inserts are to be removed with a two pronged heavy duty stainless steel tool. Urinal to be fastened at the bottom front using standard bolts from brass urinal flange. The bottom of the urinal is to be fully enclosed.

**DIMENSIONS (WxHxD)**  
**14.0 x 21.5 x 14.5 inches (356 x 546 x 368 mm)**

**APPROX. WEIGHT**  
**29 lbs ( 13.18 kg )**

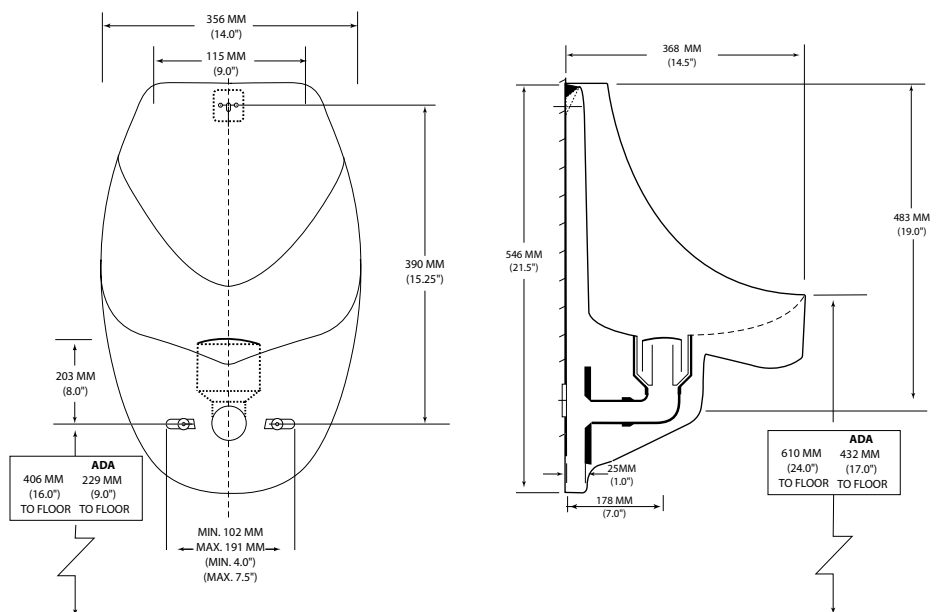

**CODES/STANDARDS APPLICABLE:** Complies with A117, ASME A112.19.19, others.

**FOR STANDARD INSTALLATION:** mount at 24" above finished floor to lip of urinal or as required by architect. Center drain line to be at 16.0" off finished floor.

 **FOR ADA REQUIREMENTS:** mount at 17" above finished floor to lip of urinal. ADA center drain line to be at 9.0" off finished floor.

Supply suitable wall support, i.e. carrier. Install and maintain as per manufacturer's instructions. Urinal 2" drain outlet installs and drains to 2" flanged waste. Retrofit or new construction. Urinal is predrilled to accept most 2" brass flanges from other manufacturer's urinals in a retrofit scenario. For new construction, specify #5001 brass urinal flange for 2" waste. Use standard sanitation practices to maintain fixture.

### NOTE ON INSTALLATION:

For startup of urinal, purchase 1 x 6009 iPack. Good for up to 5 urinals. (Includes: 1 x 1114 BlueSeal®, 1 x 4002 PortionAid and 1 x 4001 Xtraptor Tool)



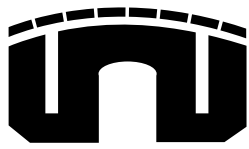

## URINAL INITIAL SET-UP



1. After urinal is installed, test for water tightness by pouring a bucket of water into the open drain hole of urinal. If no water leak is detected, caulk around the urinal, leaving approx. 8" on the bottom of the urinal uncaulked. Wipe urinal clean.



2. Take supplied *EcoTrap*® and fill with water under faucet in sink. Fill until full or water overflows on bottom.

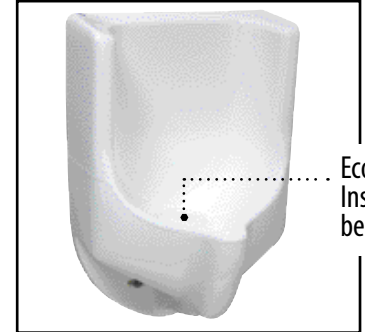

*EcoTrap*®  
Insert  
below rim.

3. Insert the water filled *EcoTrap*® into the urinal drain opening . **IMPORTANT: then press *EcoTrap*® by hand below rim.**



4. Insert and tighten Portion-Aid measuring device onto *BlueSeal*® quart bottle. Hold bottle upright. Squeeze bottle to fill Portion-Aid to 3oz. Then simply pour *BlueSeal*® from Portion-Aid into *EcoTrap*®.  
**Done!**

### **EcoTrap**® Principle

- Urine flows down into the patented Vertical **EcoTrap**® drain insert.
- In the **EcoTrap**® the urine passes through a floating layer of **BlueSeal**® liquid, which forms a barrier that prevents sewer vapors from escaping into the restroom atmosphere.
- Urine under the barrier layer overflows into the central tube and runs down into the conventional drain line.

### **How it Works!**

#### Cross-Section of the Patented Vertical *EcoTrap*®

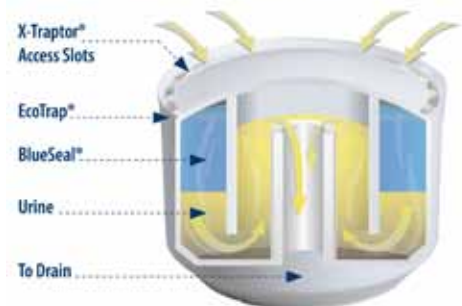

## TROUBLESHOOTING

| PROBLEM                                  | CAUSE   | REMEDY  |
|--|---|---|
| There is an odor coming from the urinal. | <ol style="list-style-type: none"> <li>BlueSeal® is depleted.</li> <li>EcoTrap® is not seated below rim.</li> <li>Urinal is not connected properly to the drain.</li> </ol> | <p>If odor comes from urinal trap, add BlueSeal®. Push EcoTrap® down below rim.</p> <p>If odor comes from below urinal, remove and reset urinal to wall and drain line.</p> <p>Also check floor drain if odor comes from here; if so, add 1 gal of water to floor drain and add 3 oz. of <b>EverPrime™</b>, our great floor drain sealer.</p> |
| Trap does not flush/flow.                | <ol style="list-style-type: none"> <li>The EcoTrap® is full.</li> <li>The drain line is plugged.</li> <li>The system is double trapped.</li> </ol>                          | <p>Replace the EcoTrap® per Maintenance Instructions.</p> <p>Remove the EcoTrap® and snake the drainline.</p> <p>Remove the drain line trap so that only the EcoTrap® is the trap for the system.</p>   |

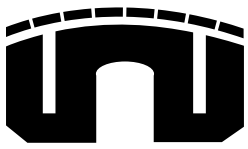

## MAINTENANCE INSTRUCTIONS: BLUESEAL REFILL

### DO NOT REMOVE TRAP FOR REFILL

One 3 oz. refill will last for approx. 1,500 uses.

**No need to refill daily!!** See interval chart to the right.



1. Screw the *PortionAid* onto a *BlueSeal* quart bottle.
2. Squeeze bottle to measure out 3 oz. of *BlueSeal* into the *PortionAid*.



3. Pour *BlueSeal* directly into *EcoTrap* towards back of urinal.

**Task Time: 20 Seconds**

### *BlueSeal* Trap Liquid Estimated Intervals

| Approximate users per day per urinal | Monthly 3 oz. <i>BlueSeal</i> refills |
|--------------------------------------|---------------------------------------|
| 1 - 75*                              | Monthly                               |
| 76 - 150*                            | Twice a Month                         |
| 151 - 225*                           | Three Times a Month                   |
| 226 - 300*                           | Weekly                                |
| * Based on a 5 day work week.        |                                       |

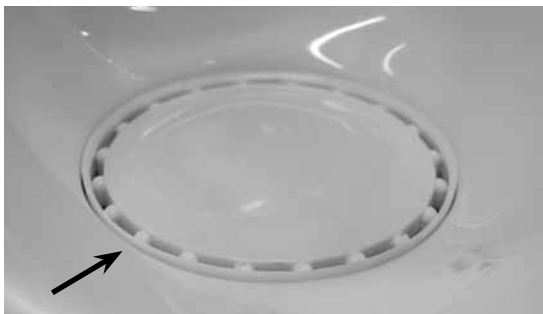

**Incorrect Seating** (above rim)

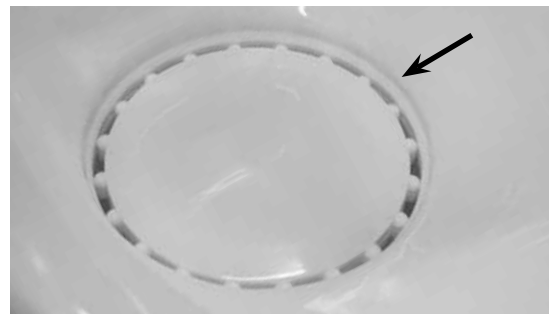

**Correct Seating** (below rim)

#### **Cleaning Instructions (Traditional):**

1. Remove any foreign objects and other debris from base of urinal bowl.
2. Use only non-abrasive cleaners and a soft sponge/mop on urinal surfaces for cleaning.
3. Use cleaner on wet sponge, cloth, or mop. Then wipe clean all surfaces of urinal, especially the lower front.
4. Dry all surfaces with a soft cloth or soft rag.

#### **Cleaning Instructions (NviroClean™):**

1. Remove any foreign objects and other debris from base of urinal bowl.
2. Spray *NviroClean*™ liberally on urinal surface starting at the top and working your way down to the plastic trap insert. Cleaning should take place once or twice a day or as wash-room traffic dictates. **DO NOT WIPE OFF OR SCRUB.**
3. Do not use any other cleaners while using *NviroClean*™.

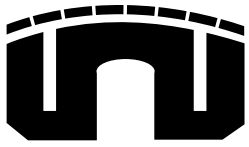

## MAINTENANCE INSTRUCTIONS

### ECOTRAP® EXCHANGE



**REMOVE OR EXCHANGE EcoTrap® ONLY WHEN NEEDED, i.e. slow urine flow or pooling. The table below shows approximate intervals.**

1. Have the X-Traptor® tool, new EcoTrap®, a plastic bag, and a deodorizer ready and on hand.
2. Insert X-Traptor® into trap slots and engage on knobs.
3. While slowly pulling up, wiggle tool side to side to loosen EcoTrap®.  
**DO NOT PULL STRAIGHT UP!** Once the EcoTrap® is removed, spray some deodorizer into the drain.
4. With EcoTrap® still on X-Traptor®, pour liquid contents into the open drain hole of urinal.
5. Deposit used EcoTrap® in plastic bag. Disengage and remove X-Traptor®.
6. Seal the plastic bag and discard in locally appropriate manner.
7. Loosen any sediment accumulation in drain hole with any long object.
8. Pour a full bucket, approx. 5 gallons, of preferably hot water into drain hole of urinal to flush sediments from waste line before inserting new EcoTrap®.
9. Take new EcoTrap® and fill with water under faucet in sink. Then set EcoTrap® insert into trapway. **Push EcoTrap® down, below rim of trapway.**
10. **Add 3 oz. of BlueSeal®. Done!**

**TASK TIME: 3-4 Minutes**

#### EcoTrap® Replacement Estimated Intervals

| Approximate users per day per urinal                 | EcoTrap® Exchange  |
|--|--------------------|
| 1 - 30*  | Once a Year        |
| 31 - 60*   | Twice a Year       |
| 61 - 90*   | Three Times a Year |
| 91 - 120*  | Four Times a Year  |
| * Based on 7,000 uses per urinal and 240 days usage. |                    |

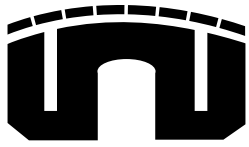

**WATERLESS**.com  
the innovative brand since 1991



### **MANUFACTURER'S LIMITED THREE YEAR WARRANTY**

Subject to the conditions and discussions set forth herein, Waterless Co. Inc. warrants its No-Flush™ urinals against defects in material or workmanship for a period of three (3) years from date of purchase. Waterless Co. Inc.'s sole obligation under this warranty shall be to repair or replace any part of the product which proves, upon our inspections, to be defective in materials and/or workmanship.

### **WARRANTY SPECIFIC CONDITIONS:**

**Failure to comply with any of the following conditions shall void this warranty in its entirety.**

1. The attached Warranty Registration Sheet must be fully completed, contain all required signatures and be mailed by the user/purchaser to Waterless Co. Inc. **within 30 days of the date of purchase.**
2. The urinal must be properly installed and operational instructions must be followed as outlined in the enclosed instructions of each urinal shipment, including the use of only authorized liquids and trap inserts, specifically BlueSeal® and EcoTrap®. Use of any other liquids or trap inserts specifically voids this warranty. Reinstatement fee may apply.
3. Repairs or replacements to the urinals or its component parts must be performed only by authorized representatives of Waterless Co. Inc., or its authorized service technicians.

### **WARRANTY EXCLUSIONS:**

This warranty does not cover damage resulting from transit, accidents, acts of God, misuse, unauthorized repairs, negligence, modifications, tampering, disconnection, improper adjustments, improper care or maintenance, improper installation, and out-of-warranty service.

Any implied warranty of merchantability or fitness for a particular purpose applicable to this product is limited to the duration of this written warranty.

Waterless Co. Inc. shall not be liable for incidental or consequential damages resulting from breach of this written warranty or any implied warranty.

The performance of repairs or needed adjustments shall be the exclusive remedy to the user/purchaser under this written warranty or any implied warranty.

This warranty gives you specific rights. You may have additional rights which vary from state to state. No person shall be authorized to change, add to, or create any warranty or obligation other than set forth herein.

### **RETURN POLICY:**

#### **ALL RETURNS MUST RECEIVE PRIOR APPROVAL BY WATERLESS CO. INC.**

Upon receipt of product, note any damages or discrepancies. Please call Waterless Co. Inc. within 10 days of receipt of product to obtain a Return Merchandise Authorization (RMA) form. Complete and return RMA within 48 hours. Return product based upon RMA needs, to be received within 10 days of issuance of RMA. Any delays may cause a reduced or denial of damage or discrepancy. Unless damaged or incorrectly delivered, a re-stocking fee will apply. Return shipping to be paid by customer, unless stated otherwise by Waterless Co. Inc.

To obtain RMA authorization, please call (800) 244-6364 or (760) 727-7723.

**WARRANTY REGISTRATION CARD  
FOR WATERLESS NO-FLUSH™ URINALS**

To register a valid Warranty for No-Flush™ urinals, please complete all sections and required signatures below and **return it to Waterless Co. Inc. within 30 days of your purchase.**

Company: \_\_\_\_\_ Name: \_\_\_\_\_ Title: \_\_\_\_\_

Address: \_\_\_\_\_

City: \_\_\_\_\_ State: \_\_\_\_\_ Zip Code: \_\_\_\_\_ Tel: (\_\_\_\_) \_\_\_\_\_

Fax: (\_\_\_\_) \_\_\_\_\_ E-Mail: \_\_\_\_\_ Purchased From: \_\_\_\_\_

Model# 2003\_\_2004\_\_2005\_\_2104\_\_2902\_\_2903\_\_Other \_\_\_\_\_ Purchase Date: \_\_\_\_\_

Installed By Company: \_\_\_\_\_ Name: \_\_\_\_\_ Tel: (\_\_\_\_) \_\_\_\_\_

Waste Line Cleaned before Installation: \_\_\_Yes\_\_\_No\_\_\_ Rough-In needed to be changed: \_\_\_Yes\_\_\_No\_\_\_

Replaces Existing Fixtures: \_\_\_Yes\_\_\_No\_\_\_ New Installation: \_\_\_Yes\_\_\_No\_\_\_

Type of Facility: \_\_\_\_\_ Commercial\_\_\_\_\_ Institutional\_\_\_\_\_ Military\_\_\_\_\_ Other \_\_\_\_\_

*THANK YOU for purchasing WATERLESS NO-FLUSH™ urinals.*

===== FOLD HERE AND TAPE ON OPEN END. =====

FROM: \_\_\_\_\_  
\_\_\_\_\_  
\_\_\_\_\_

**PLACE  
STAMP  
HERE**

**WATERLESS.com**  
**1050 JOSHUA WAY**  
**VISTA, CA 92081**

**1.800.244.6364**